

> № 8C 性能参数表

转速 (r/min)	序号 No.	流量 (m³/h)	全压 (Pa)	静压 (Pa)	内效率 (%)	轴功率 (kW)	电机功率
1650	1	18135	2871	2763	78.5	19.41	30kW-4
	2	20449	2850	2711	82.5	20.66	
	3	22762	2785	2614	86.6	21.67	
	4	25076	2638	2430	87.1	22.22	
	5	27390	2430	2183	86.8	22.41	
	6	29704	2196	1905	84.3	22.64	
	7	32017	1906	1567	78.6	22.70	
	8	34331	1547	1157	70.5	22.02	
1560	1	17146	2567	2470	78.5	16.40	22kW-4
	2	19333	2547	2424	82.5	17.46	
	3	21521	2490	2337	86.6	18.31	
	4	23708	2358	2172	87.1	18.78	
	5	25896	2173	1951	86.8	18.94	
	6	28083	1963	1703	84.3	19.13	
	7	30271	1704	1401	78.6	19.19	
	8	32458	1382	1034	70.5	18.61	
1455	1	15992	2233	2148	78.5	13.31	18.5kW-4
	2	18032	2216	2108	82.5	14.16	
	3	20072	2166	2033	86.6	14.86	
	4	22113	2051	1890	87.1	15.23	
	5	24153	1890	1697	86.8	15.37	
	6	26193	1708	1481	84.3	15.52	
	7	28233	1482	1219	78.6	15.57	
	8	30274	1203	900	70.5	15.10	
1160	1	12749	1419	1365	78.5	6.74	11kW-4
	2	14376	1408	1340	82.5	7.18	
	3	16003	1377	1292	86.6	7.53	
	4	17629	1304	1201	87.1	7.72	
	5	19256	1201	1079	86.8	7.79	
	6	20883	1085	941	84.3	7.87	
	7	22509	942	775	78.6	7.89	
	8	24136	764	572	70.5	7.65	
1090	1	11980	1253	1206	78.5	5.59	7.5kW-4
	2	13508	1244	1183	82.5	5.96	
	3	15037	1216	1141	86.6	6.25	
	4	16565	1151	1061	87.1	6.40	
	5	18094	1061	953	86.8	6.46	
	6	19622	958	831	84.3	6.53	
	7	21151	832	684	78.6	6.54	
	8	22679	675	505	70.5	6.35	
950	1	10441	952	916	78.5	3.70	5.5kW-4
	2	11773	945	899	82.5	3.94	
	3	13106	923	867	86.6	4.14	
	4	14438	874	806	87.1	4.24	
	5	15770	806	724	86.8	4.28	
	6	17102	728	631	84.3	4.32	
	7	18434	632	520	78.6	4.33	
	8	19766	513	384	70.5	4.20	



# DF73 系列离心通风机

## DF73 Series Centrifugal Fan

### > No 9C 性能参数表

转速 (r/min)	序号 No.	流量 (m³/h)	全压 (Pa)	静压 (Pa)	内效率 (%)	轴功率 (kW)	电机功率
1500	1	23473	3003	2890	78.5	26.27	37kW-4
	2	26468	2981	2836	82.5	27.97	
	3	29463	2913	2734	86.6	29.33	
	4	32458	2759	2542	87.1	30.08	
	5	35453	2542	2283	86.8	30.35	
	6	38448	2297	1992	84.3	30.65	
	7	41443	1994	1639	78.6	30.74	
	8	44438	1618	1210	70.5	29.81	
1370	1	21439	2505	2411	78.5	20.02	30kW-4
	2	24174	2486	2366	82.5	21.31	
	3	26910	2430	2281	86.6	22.35	
	4	29645	2302	2121	87.1	22.92	
	5	32380	2121	1904	86.8	23.12	
	6	35116	1916	1662	84.3	23.35	
	7	37851	1663	1368	78.6	23.42	
	8	40586	1349	1010	70.5	22.72	
1235	1	19327	2036	1959	78.5	14.66	22kW-4
	2	21792	2020	1922	82.5	15.61	
	3	24258	1975	1854	86.6	16.37	
	4	26724	1870	1723	87.1	16.79	
	5	29190	1723	1548	86.8	16.94	
	6	31655	1557	1350	84.3	17.11	
	7	34121	1351	1111	78.6	17.15	
	8	36587	1097	821	70.5	16.64	
1170	1	18309	1827	1758	78.5	12.47	18.5kW-4
	2	20645	1813	1725	82.5	13.27	
	3	22981	1772	1664	86.6	13.92	
	4	25317	1679	1547	87.1	14.27	
	5	27653	1547	1389	86.8	14.40	
	6	29989	1397	1212	84.3	14.55	
	7	32325	1213	997	78.6	14.59	
	8	34661	984	736	70.5	14.15	
1010	1	15805	1362	1310	78.5	8.02	11kW-4
	2	17822	1351	1286	82.5	8.54	
	3	19839	1321	1240	86.6	8.96	
	4	21855	1251	1153	87.1	9.18	
	5	23872	1153	1035	86.8	9.26	
	6	25888	1041	903	84.3	9.36	
	7	27905	904	743	78.6	9.38	
	8	29921	733	549	70.5	9.10	
800	1	12519	854	822	78.5	3.99	5.5kW-6
	2	14116	848	807	82.5	4.24	
	3	15714	829	778	86.6	4.45	
	4	17311	785	723	87.1	4.56	
	5	18908	723	649	86.8	4.60	
	6	20506	653	567	84.3	4.65	
	7	22103	567	466	78.6	4.66	
	8	23700	460	344	70.5	4.52	

> № 10C 性能参数表

转速 (r/min)	序号 No.	流量 (m³/h)	全压 (Pa)	静压 (Pa)	内效率 (%)	轴功率 (kW)	电机功率
1460	1	31341	3513	3380	78.5	41.03	55kW-4
	2	35340	3486	3317	82.5	43.67	
	3	39338	3407	3198	86.6	45.81	
	4	43337	3227	2973	87.1	46.97	
	5	47336	2973	2670	86.8	47.39	
	6	54334	2687	2330	84.3	47.86	
	7	55333	2332	1918	78.6	48.00	
	8	59332	1892	1416	70.5	46.56	
1240	1	26618	2534	2438	78.5	25.14	37kW-4
	2	30014	2515	2393	82.5	26.76	
	3	33411	2458	2307	86.6	28.06	
	4	36807	2328	2145	87.1	28.78	
	5	40203	2145	1926	86.8	29.03	
	6	43599	1938	1681	84.3	29.32	
	7	46995	1682	1383	78.6	29.40	
	8	50391	1365	1021	70.5	28.52	
1160	1	24901	2217	2134	78.5	20.58	30kW-4
	2	28078	2201	2094	82.5	21.90	
	3	31255	2151	2019	86.6	22.98	
	4	34432	2037	1877	87.1	23.56	
	5	37609	1877	1686	86.8	23.77	
	6	40786	1696	1470	84.3	24.01	
	7	43963	1472	1210	78.6	24.07	
	8	47140	1194	894	70.5	23.35	
980	1	21037	1583	1523	78.5	12.41	18.5kW-4
	2	23721	1571	1495	82.5	13.21	
	3	26405	1535	1441	86.6	13.85	
	4	29089	1454	1340	87.1	14.21	
	5	31773	1340	1203	86.8	14.33	
	6	34457	1210	1050	84.3	14.48	
	7	37141	1051	864	78.6	14.52	
	8	39825	852	638	70.5	14.08	
810	1	17388	1081	1040	78.5	7.01	11kW-6
	2	19606	1073	1021	82.5	7.46	
	3	21825	1049	984	86.6	7.82	
	4	24043	993	915	87.1	8.02	
	5	26262	915	822	86.8	8.09	
	6	28480	827	717	84.3	8.17	
	7	30698	718	590	78.6	8.20	
	8	32917	582	436	70.5	7.95	
720	1	15456	854	822	78.5	4.92	7.5kW-6
	2	17428	848	807	82.5	5.24	
	3	19400	829	778	86.6	5.49	
	4	21372	785	723	87.1	5.63	
	5	23344	723	649	86.8	5.68	
	6	25316	653	567	84.3	5.74	
	7	27287	567	466	78.6	5.76	
	8	29259	460	344	70.5	5.58	



# DF73 系列离心通风机

## DF73 Series Centrifugal Fan

> № 11C 性能参数表

转速 (r/min)	序号 No.	流量 (m³/h)	全压 (Pa)	静压 (Pa)	内效率 (%)	轴功率 (kW)	电机功率
1380	1	39429	3797	3654	78.5	55.80	75kW-4
	2	44460	3768	3586	82.5	59.40	
	3	49490	3684	3457	86.6	62.30	
	4	54521	3489	3214	87.1	63.88	
	5	59551	3214	2887	86.8	64.45	
	6	64582	2904	2519	84.3	65.10	
	7	69613	2521	2073	78.6	65.28	
	8	74643	2045	1531	70.5	63.32	
1240	1	35429	3066	2950	78.5	40.48	55kW-4
	2	39949	3043	2895	82.5	43.09	
	3	44469	2974	2791	86.6	45.20	
	4	48990	2817	2595	87.1	46.35	
	5	53510	2595	2331	86.8	46.76	
	6	58030	2345	2034	84.3	47.23	
	7	62550	2035	1674	78.6	47.36	
	8	67071	1651	1236	70.5	45.94	
990	1	28286	1954	1880	78.5	20.60	30kW-4
	2	31895	1939	1845	82.5	21.93	
	3	35504	1896	1779	86.6	23.00	
	4	39113	1795	1654	87.1	23.59	
	5	42722	1654	1486	86.8	23.80	
	6	46331	1495	1296	84.3	24.03	
	7	49940	1297	1067	78.6	24.10	
	8	53548	1053	788	70.5	23.38	
860	1	24572	1475	1419	78.5	13.50	18.5kW-6
	2	27707	1464	1393	82.5	14.38	
	3	30842	1431	1343	86.6	15.08	
	4	33977	1355	1248	87.1	15.46	
	5	37112	1248	1121	86.8	15.60	
	6	40247	1128	978	84.3	15.75	
	7	43382	979	805	78.6	15.80	
	8	46517	794	594	70.5	15.32	
720	1	20572	1034	995	78.5	7.92	11kW-6
	2	23196	1026	976	82.5	8.44	
	3	25821	1003	941	86.6	8.85	
	4	28446	950	875	87.1	9.07	
	5	31070	875	786	86.8	9.15	
	6	33695	791	686	84.3	9.25	
	7	36320	686	564	78.6	9.27	
	8	38944	557	417	70.5	8.99	

> № 12C 性能参数表

转速 (r/min)	序号 No.	流量 (m <sup>3</sup> /h)	全压 (Pa)	静压 (Pa)	内效率 (%)	轴功率 (kW)	电机功率
1250	1	46367	3708	3568	78.5	64.07	90kW-4
	2	52283	3680	3501	82.5	68.20	
	3	58199	3597	3376	86.6	71.54	
	4	64115	3406	3138	87.1	73.35	
	5	70031	3139	2819	86.8	74.01	
	6	75947	2836	2459	84.3	74.75	
	7	81862	2461	2024	78.6	74.95	
	8	87778	1997	1494	70.5	72.71	
1180	1	43771	3304	3179	78.5	53.90	75kW-4
	2	49355	3279	3120	82.5	57.37	
	3	54940	3205	3008	86.6	60.18	
	4	60524	3036	2797	87.1	61.71	
	5	66109	2797	2512	86.8	62.26	
	6	71694	2527	2192	84.3	62.88	
	7	77278	2193	1804	78.6	63.05	
	8	82863	1780	1332	70.5	61.16	
1050	1	38949	2616	2517	78.5	37.97	55kW-4
	2	43918	2596	2471	82.5	40.42	
	3	48887	2538	2382	86.6	42.40	
	4	53857	2404	2214	87.1	43.48	
	5	58826	2215	1989	86.8	43.86	
	6	63795	2001	1735	84.3	44.30	
	7	68764	1737	1428	78.6	44.42	
	8	73734	1409	1054	70.5	43.09	
930	1	34497	2052	1975	78.5	26.39	37kW-6
	2	38899	2037	1938	82.5	28.09	
	3	43300	1991	1869	86.6	29.46	
	4	47702	1886	1737	87.1	30.21	
	5	52103	1737	1560	86.8	30.48	
	6	56504	1570	1361	84.3	30.78	
	7	60906	1362	1120	78.6	30.87	
	8	65307	1105	827	70.5	29.94	
730	1	27079	1265	1217	78.5	12.76	18.5kW-6
	2	30533	1255	1194	82.5	13.58	
	3	33988	1227	1151	86.6	14.25	
	4	37443	1162	1070	87.1	14.61	
	5	40898	1070	961	86.8	14.74	
	6	44353	967	839	84.3	14.89	
	7	47808	839	690	78.6	14.93	
	8	51263	681	510	70.5	14.48	



# DF73 系列离心通风机

## DF73 Series Centrifugal Fan

> № 14C 性能参数表

转速 (r/min)	序号 No.	流量 (m³/h)	全压 (Pa)	静压 (Pa)	内效率 (%)	轴功率 (kW)	电机功率
1030	1	60671	3427	3297	78.5	77.48	110kW-4
	2	68412	3401	3236	82.5	82.47	
	3	76152	3324	3120	86.6	86.51	
	4	83893	3148	2900	87.1	88.70	
	5	91634	2901	2605	86.8	89.49	
	6	99375	2621	2273	84.3	90.39	
	7	107115	2275	1871	78.6	90.64	
	8	114856	1846	1381	70.5	87.92	
970	1	57137	3039	2924	78.5	64.71	90kW-4
	2	64427	3016	2870	82.5	68.88	
	3	71716	2948	2767	86.6	72.25	
	4	79006	2792	2572	87.1	74.09	
	5	86296	2572	2310	86.8	74.75	
	6	93586	2324	2016	84.3	75.49	
	7	100876	2017	1659	78.6	75.70	
	8	108166	1637	1225	70.5	73.43	
820	1	48301	2172	2090	78.5	39.09	55kW-6
	2	54464	2155	2051	82.5	41.61	
	3	60626	2107	1977	86.6	43.65	
	4	66789	1995	1838	87.1	44.76	
	5	72951	1838	1651	86.8	45.16	
	6	79114	1661	1441	84.3	45.61	
	7	85276	1442	1186	78.6	45.73	
	8	91439	1170	875	70.5	44.36	
720	1	42411	1674	1611	78.5	26.46	37kW-6
	2	47822	1662	1581	82.5	28.17	
	3	53233	1624	1524	86.6	29.55	
	4	58644	1538	1417	87.1	30.30	
	5	64055	1417	1273	86.8	30.57	
	6	69466	1281	1111	84.3	30.87	
	7	74877	1111	914	78.6	30.96	
	8	80288	902	675	70.5	30.03	
610	1	35931	1202	1156	78.5	16.09	22kW-6
	2	40516	1193	1135	82.5	17.13	
	3	45100	1166	1094	86.6	17.97	
	4	49684	1104	1017	87.1	18.43	
	5	54269	1017	914	86.8	18.59	
	6	58853	919	797	84.3	18.77	
	7	63437	798	656	78.6	18.83	
	8	68022	647	484	70.5	18.26	

> № 16D 性能参数表

转速 (r/min)	序号 No.	流量 (m³/h)	全压 (Pa)	静压 (Pa)	内效率 (%)	轴功率 (kW)	电机功率
1450	1	127493	8870	8534	78.5	408.5	所配电机根据具体 使用条件来指定
	2	143760	8802	8376	82.5	434.9	
	3	160026	8604	8075	86.6	456.1	
	4	176292	8149	7507	87.1	467.7	
	5	192559	7508	6743	86.8	471.9	
	6	208825	6784	5884	84.3	476.6	
	7	225091	5888	4842	78.6	477.9	
	8	241358	4777	3575	70.5	463.6	
960	1	84409	3888	3741	78.5	118.6	160kW-6
	2	95179	3858	3671	82.5	126.2	
	3	105948	3771	3540	86.6	132.4	
	4	116718	3572	3291	87.1	135.7	
	5	127487	3291	2955	86.8	136.9	
	6	138257	2974	2579	84.3	138.3	
	7	149026	2581	2122	78.6	138.7	
	8	159795	2094	1567	70.5	134.5	



# DF73 系列离心通风机 DF73 Series Centrifugal Fan

> № 8C 性能曲线图

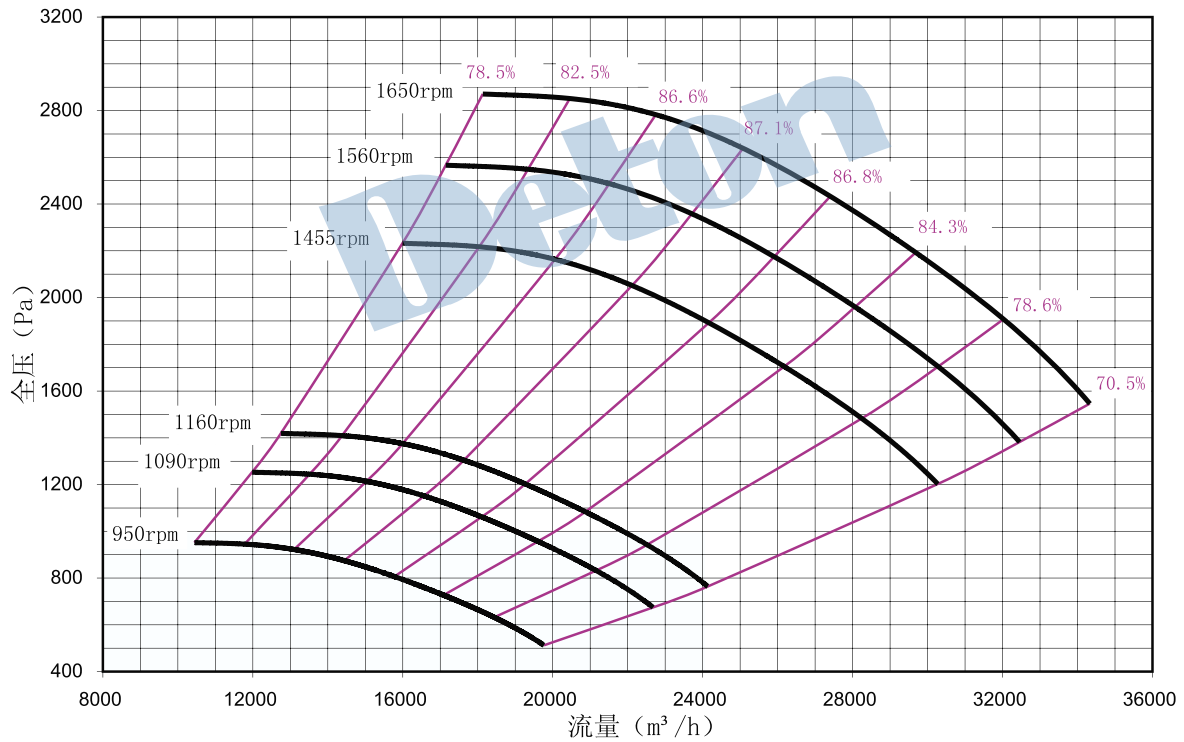

> № 9C 性能曲线图

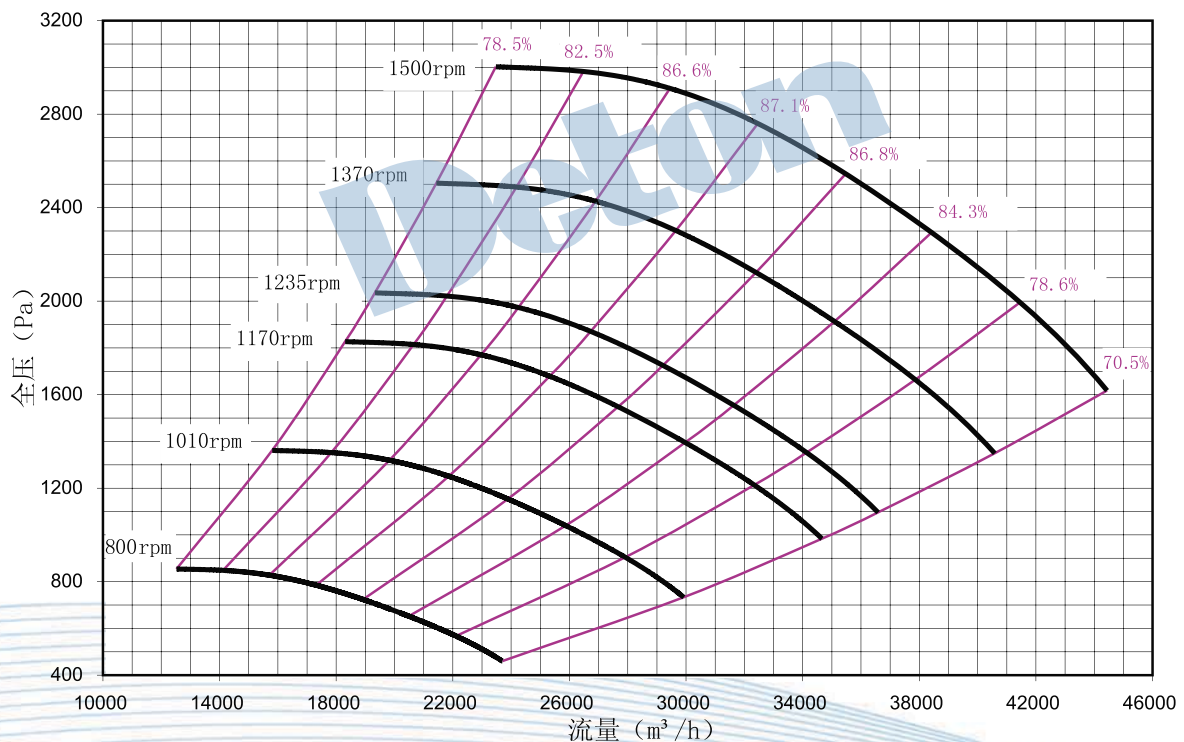



> № 10C 性能曲线图

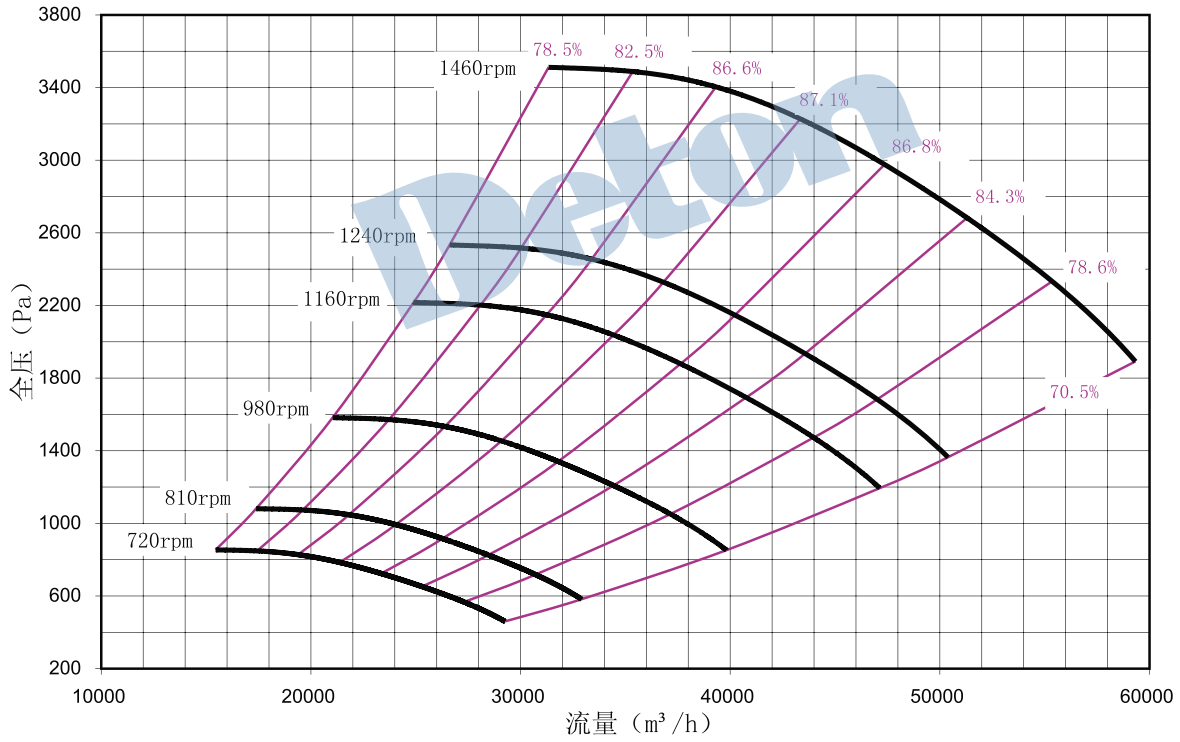

> № 11C 性能曲线图

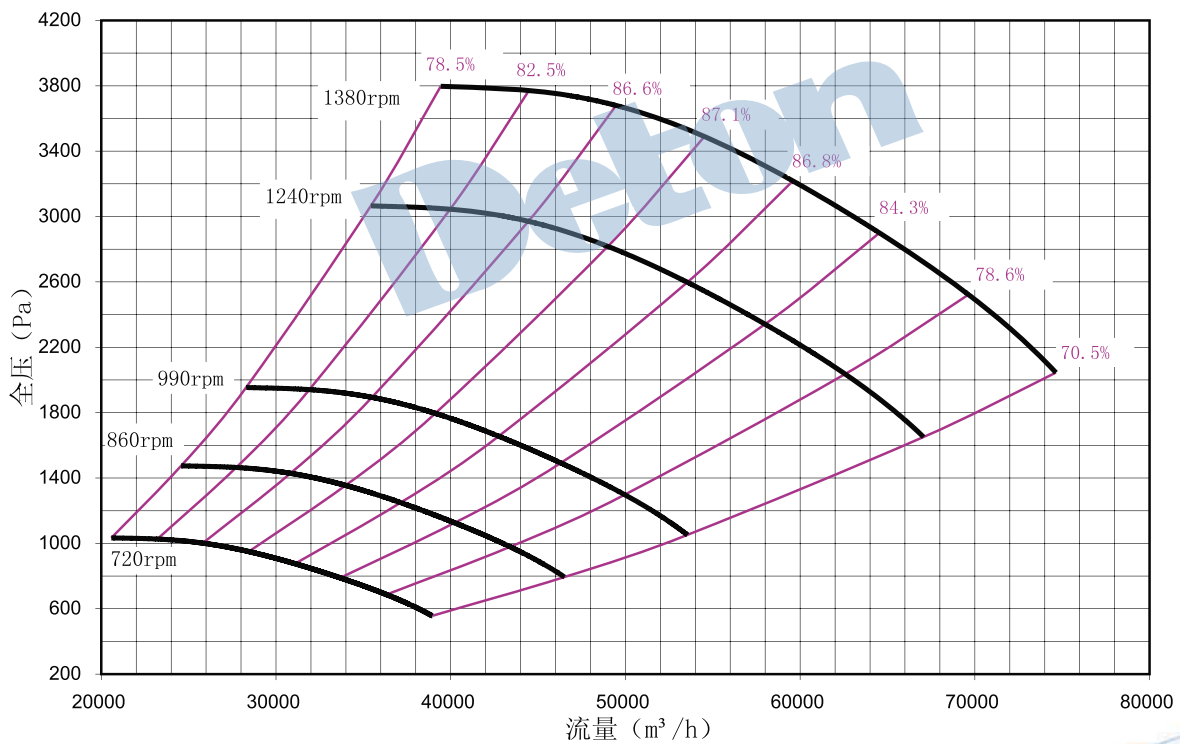



# DF73 系列离心通风机 DF73 Series Centrifugal Fan

> № 12C 性能曲线图

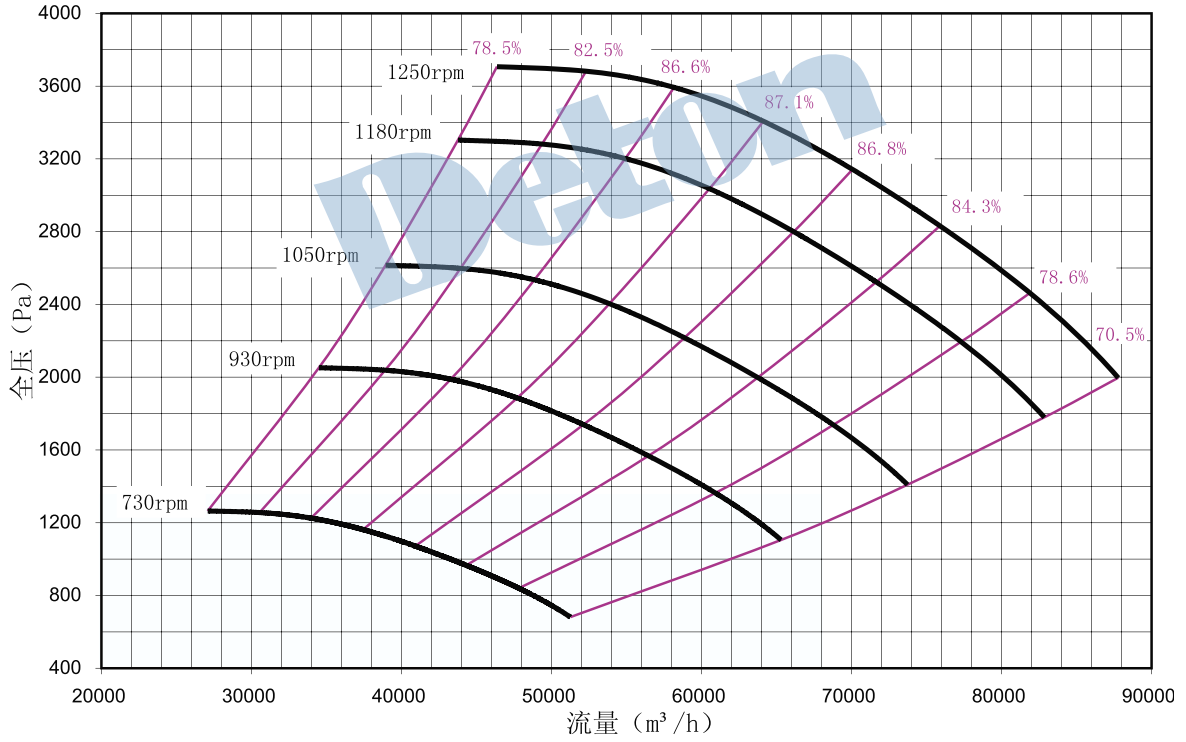

> № 14C 性能曲线图

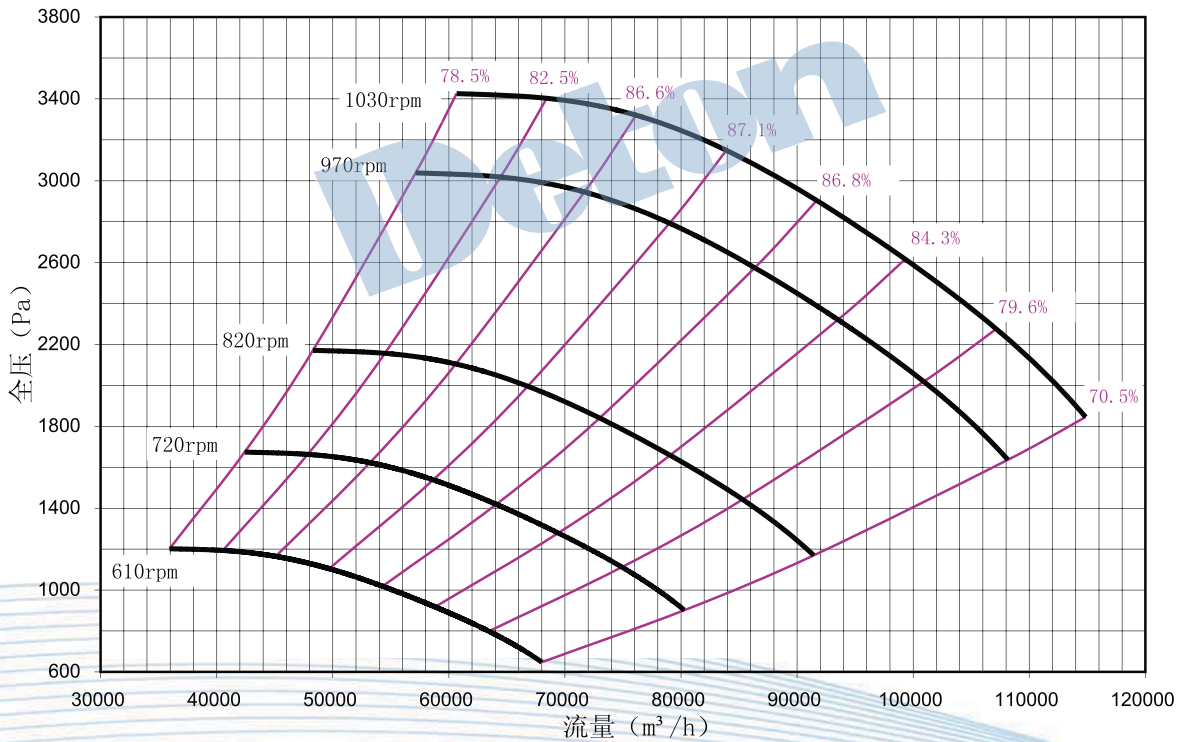

> № 16D 性能曲线图

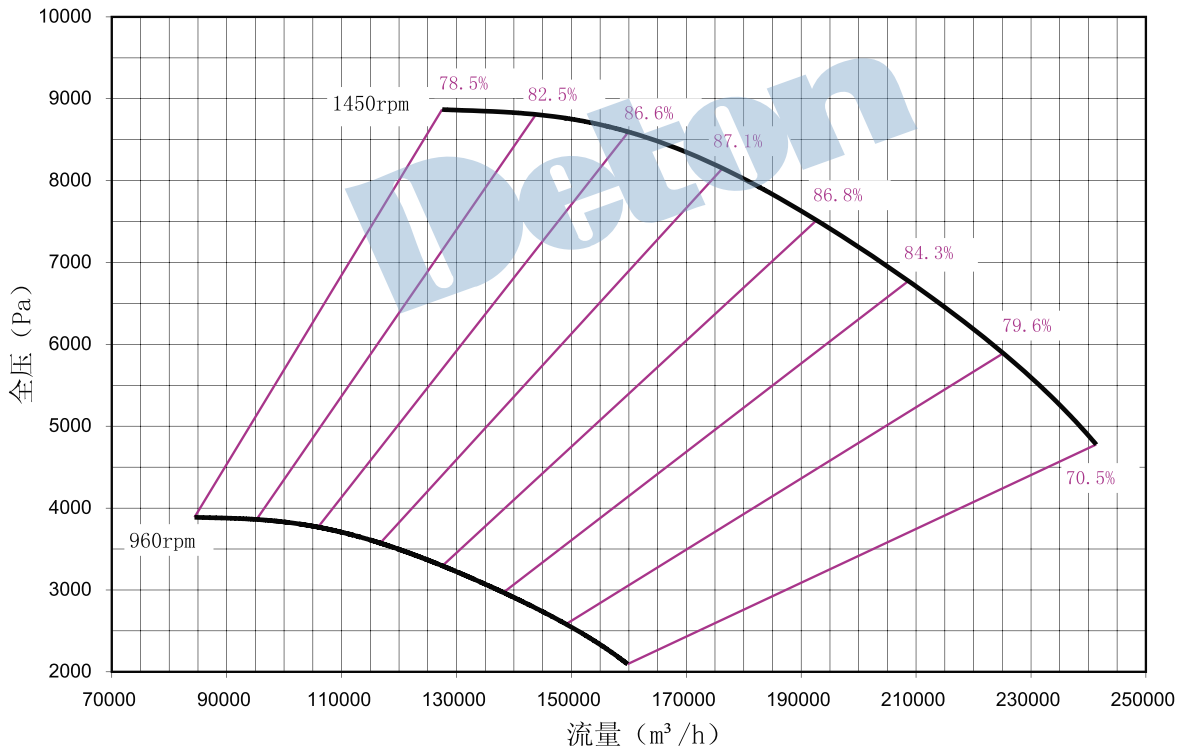

> C 式外形安装尺寸

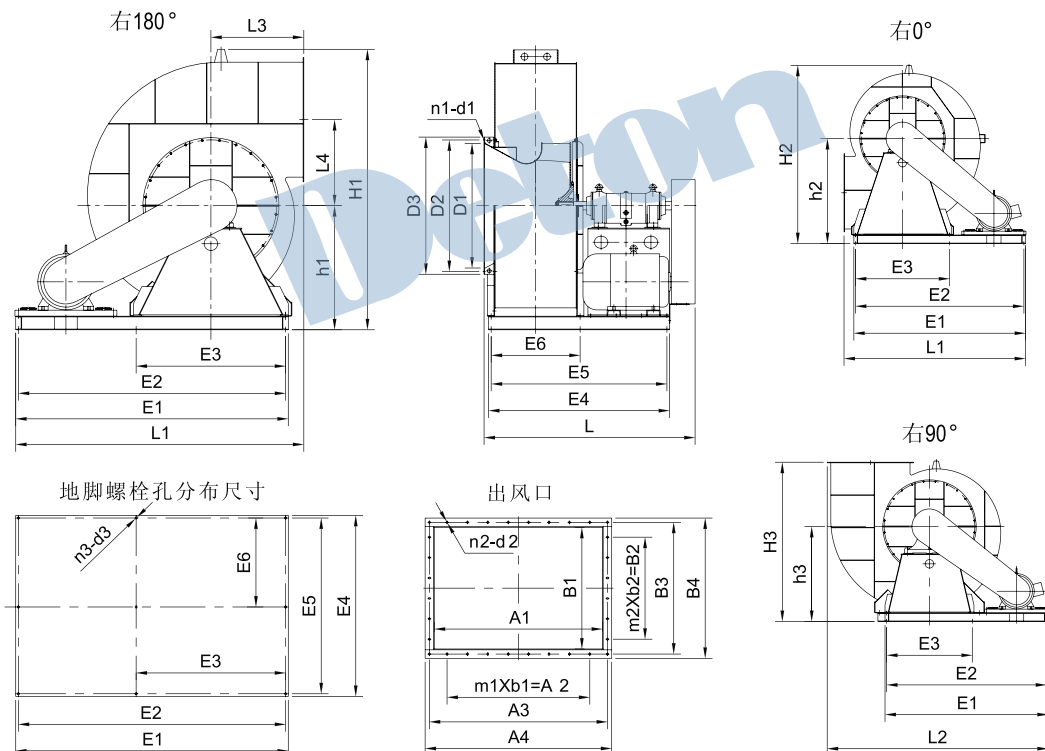



# DF73 系列离心通风机

## DF73 Series Centrifugal Fan

机号 Model	进风口				出风口									外形尺寸					
	D1	D2	D3	n1-d1	A1	m1xb1=A2	A3	A4	B1	m2xb2=B2	B3	B4	n2-b2	H1	H2	H3	h1	h2	h3
8C	Φ800	Φ860	Φ910	16-Φ15	720	5x120=600	766	806	520	3x120=360	568	608	24-Φ10	1800	1850	1550	805	1011	940
9C	Φ900	Φ970	Φ1010	16-Φ15	810	6x120=720	858	898	585	4x120=480	633	673	24-Φ10	2005	2035	1717	890	1210	1040
10C	Φ1000	Φ1070	Φ1130	16-Φ15	900	8x100=800	958	1008	650	5x100=500	708	758	34-Φ12	2234	2294	1870	990	1370	1170
11C	Φ1100	Φ1160	Φ1210	24-Φ15	990	7x120=840	1048	1098	715	5x120=600	775	825	32-Φ12	2475	2496	2070	1095	1470	1250
12C	Φ1200	Φ1270	Φ1310	24-Φ15	1080	8x125=1000	1160	1210	780	5x125=625	862	912	34-Φ15	2633	2689	2230	1140	1580	1330
14C	Φ1400	Φ1470	Φ1530	24-Φ15	1260	10x115=1150	1340	1390	910	7x115=805	992	1042	42-Φ15	3051	3103	2550	1330	1830	1550

机号 Model	功率 Power	外形安装尺寸					地脚安装尺寸							重量 (kg)
		L	L1	L2	L3	L4	E1	E2	E3	E4	E5	E6	n3-d3	
8C	30kW	1520	2020	2365	610	552	1910	1870	960	1330	1290	591	9-Φ19	813(0°) 794(90°) 773(180°)
	11kW ~ 22kW						1810	1770						
	5.5kW ~ 7.5kW						1710	1670						
9C	30kW ~ 37kW	1578	2150	2540	680	621	2030	1990	1080	1390	1350	665	9-Φ19	942(0°) 920(90°) 898(180°)
	11kW ~ 22kW						1930	1890						
	5.5kW						1830	1790						
10C	55kW	1795	2263	2757	700	690	2086	2040	1000	1542	1496	730	9-Φ19	1185(0°) 1160(90°) 1120(180°)
	30kW ~ 37kW						1986	1940						
	7.5kW ~ 18.5kW						1886	1840						
11C	55kW ~ 75kW	1864	2483	2971	820	759	2286	2240	1200	1597	1551	785	9-Φ19	1430(0°) 1387(90°) 1346(180°)
	18.5kW ~ 30kW						2186	2140						
	11kW						2086	2040						
12C	37kW ~ 90kW	2228	2563	3096	900	828	2286	2240	1200	1938	1892	864	9-Φ19	2028(0°) 1957(90°) 1892(180°)
	18.5kW						2186	2140						
14C	110kW	2368	2868	3529	1000	966	2596	2540	1400	2065	2009	994	9-Φ19	2636(0°) 2592(90°) 2500(180°)
	37kW ~ 90kW						2496	2440						
	22kW						2396	2340						

注：表中的重量数据不包含配用电机和皮带轮的重量。